

501 Ruggedized Shaft encoder, Incremental

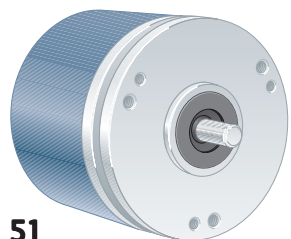

51

Short description:

- >> 2 short-circuit protected outputs
- >> IP 67 at housing, IP 66 at shaft inlet
- >> 9...36 Vdc
- >> Robust housing for harsh environment
- >> Shock and vibration protected

Suitable applications:

- >> Standard to demanding industrial applications
- >> Extra rugged design for harsh environments

General information

Encoder data	
Type	RSI 501
Operating temperature	-40°C .. +70°C
Storage temperature	-40°C .. +85°C
Ingress protection class	IP-67 according to IEC 60529
At shaft inlet	IP-66 according to IEC 60529
Vibration (55 to 2000Hz)	< 300 m/s ² according to IEC 60068-2-6 ⁽¹⁾
Shock (6ms)	< 2000 m/s ² according to IEC 60068-2-27
Cover material	Aluminium
Cover surface treatment	Coated and cromated or anodized
Weight	Approx. 300g
Accuracy and resolution	
Line count	1..5 000 ppr
Dividing error	± 50 °el
Channel separation	90 ± 25 °el
Measuring steps	4 x Line count

Flange option

Flange type	51, LL58
Outer diameter	ø58 mm
Mounting holes	3 x M3 & 3 x M4
Flange material	Aluminium
Surface treatment	Anodized

Shaft option

Shaft type	Ø6 round	Ø6 with face	Ø10 round	Ø10 with face
Axial shaft load	100 N	100 N	100 N	100 N
Radial shaft load	120 N	120 N	120 N	120 N
Mech. permissible speed	3000 rpm (6000)	3000 rpm (6000)	3000 rpm (6000)	3000 rpm (6000)
Shaft material	Stainless steel	Stainless steel	Stainless steel	Stainless steel
Moment of inertia	1,9 x 10 ⁻⁶ kgm ²	1,9 x 10 ⁻⁶ kgm ²	2,0 x 10 ⁻⁶ kgm ²	2,0 x 10 ⁻⁶ kgm ²

⁽¹⁾<150m/s² on encoders with connectors

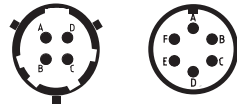

Connection option

Connector type	Cable	4 pin PT	6 pin MS	Terminal
Function	Colour	PIN	PIN	PIN
S00	Yellow	B	D	3
S90	Green	A	A	4
+E Volt	Red	C	E	1
0 Volt	Blue	D	F	2
Case	Shield	Chassis	Chassis	Chassis
Connecting direction				
Axial	Yes	No	Yes	Yes
Radial	Yes	Yes	No	No

Electrical option

Power supply	9-36 V
Polarity protected	Yes
Output signals	HC-HTL
Short circuit protected	Yes
Current consumption	55 mA at 24Vdc
Max consumption	Max 80 mA
Output load (max)	±40 mA
Output frequency (max)	100 kHz
U_{high} at 10mA load	> +EV - 4.0 V
U_{low} at 10mA load	< 2.5 V
Cable length (max)	350 m @ 100kHz

Output circuit

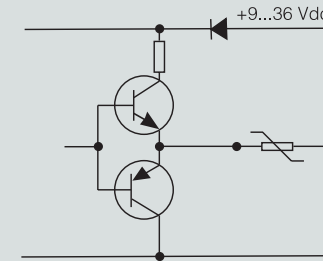

Output signals

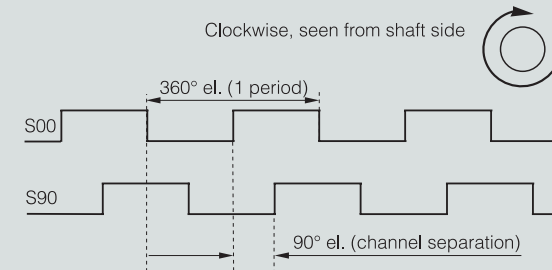



Dimensions

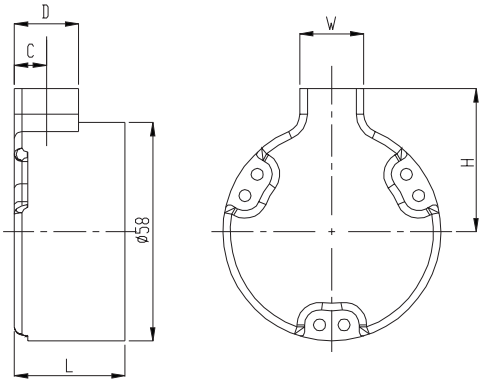

Connector	Orientation	L	H	W	D	C
Cable	Radial	29.4	34	17	17	8.5
	Axial	38.9	-	-	-	-
PT 4p	Radial	39.9	34.9	21	21	10.5
MS 6p	Axial	38.9	-	-	-	-
Terminal	Axial	29.4	-	-	-	-

Flanges

51, LL58

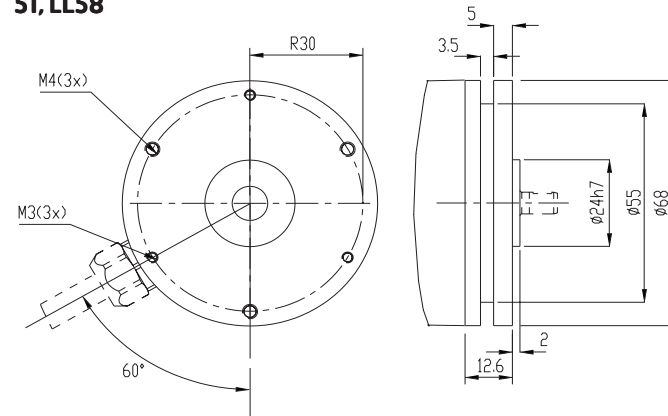

Connectors

Cable
5x2x0,25 shielded

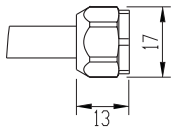

4pin PT

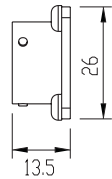

6pin MS

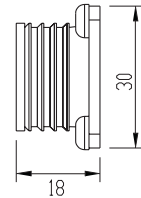

Terminal

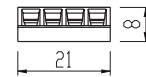

Shafts

6 mm with face

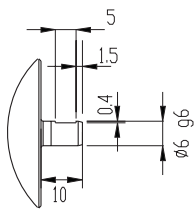

6 mm round

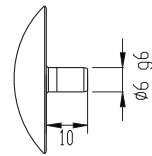

10 mm with face

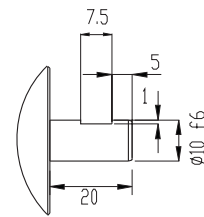

10 mm round

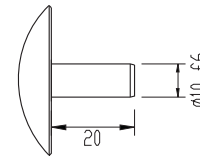

Various combinations/example

RSI 501 51
6 mm with face, radial PT

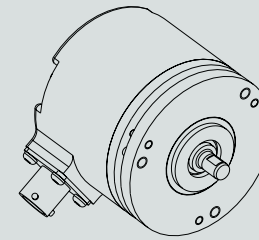

Ordering information Tick your choice

Type	RSI 501				
Flange	51, LL58				
Shaft	Ø6 round	Ø6 with face	Ø10 round	Ø10 with face	
Electronics	Supply 9-36Vdc				
Output	HC-HTL				
Connection	Cable	4 pin PT	6 pin MS	Terminal	
Connecting direction	Axial/Radial	Radial	Axial	Axial	
Line count	1..5000				

Please, specify line count and cable length when ordering

Ordering example: RSI 501 51 Ø6ro 9-36Vdc 1024ppr HC-HTL Terminal Axial